

Grubberteile direkt

PREMIUM P·A·R·T·S

vom Hersteller

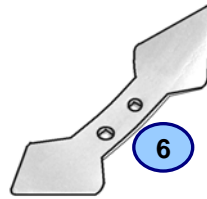
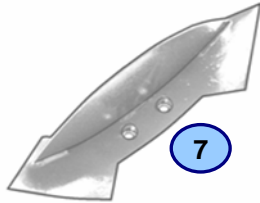
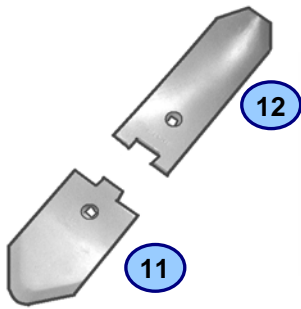

universal

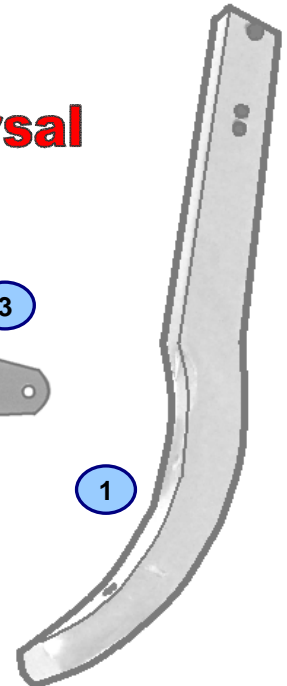
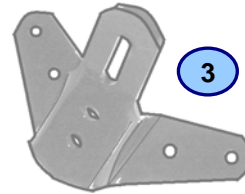

passend für alle Marken

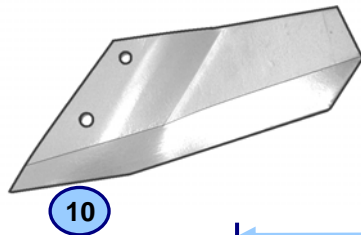
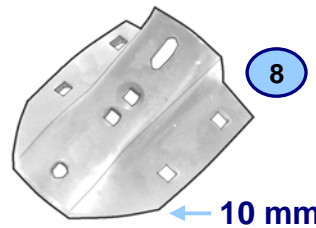
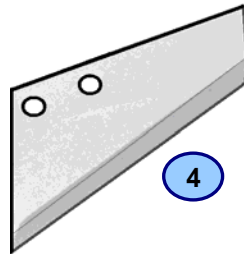
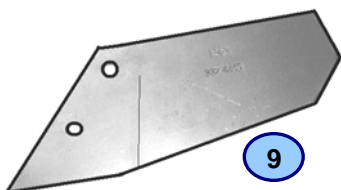

viele Teile lagernd

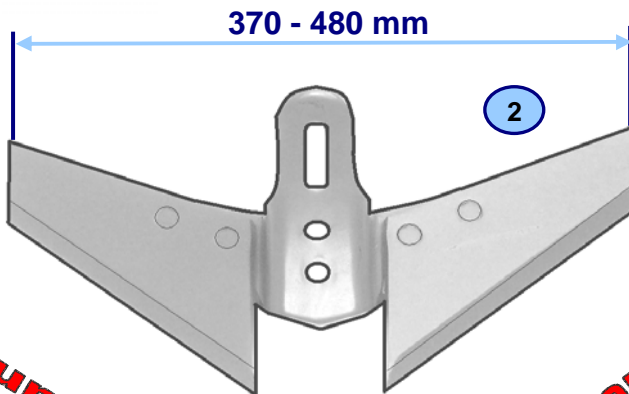
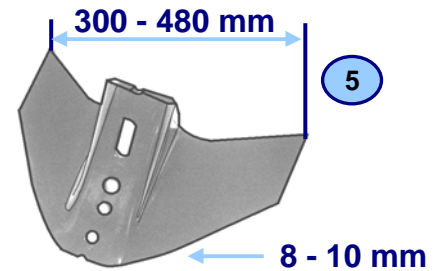

**hart und
abriebfest**

**Sonderanfertigungen
möglich**

Fragen Sie unser Team!

Tel.-Nr.: 0043 38 58/6055-0
Fax: 0043 38 58/6055 409

PREMIUM PARTS
PRODUKTIONS GMBH
office@premium-parts.com

Grazer Straße 1
8661 Wartberg

Rechnungs-u.Lieferadresse

Fax an / to +43 3858 6055 409

.....

.....

Kontaktpersonerson:

.....

Anfrage / Bestellung

Datum

Bild picture	passend für	Art. Nr.	Ref. Nr.		STK pcs	EUR / Stk. EUR / pcs	Summe Total EUR
1	Grubberstiele			44,5 mm			
	Grubberstiele			60 mm			
	Grubberstiele 720			70 mm			
	Grubberstiele			75 mm			
2	Flügelschar komplett	CV0 046 00		370 mm			
	Flügelschar komplett	CV0 046 0A		420 mm			
	Flügelschar komplett	CV0 046 0B		480 mm			
3	Halteplatte	CV0 045 05					
4	Flügelschar	CV0 045 06		370 mm rechts			
	Flügelschar	CV0 045 07		370 mm links			
	Flügelschar	CV0 045 08		420 mm rechts			
	Flügelschar	CV0 045 09		420 mm links			
	Flügelschar	CV0 045 10		480 mm rechts			
	Flügelschar	CV0 045 11		480 mm links			
5	Monoblock	CV0 060 22A		400 x 10 mm			
	Monoblock	CV0 080 05		480 x 10 mm			
	Monoblock	CV0 080 06a		430 x 10 mm			
	Monoblock	CV0 080 07		330 x 10 mm			
	Monoblock	CV0 080 08		270 x 10 mm			
	Monoblock			430 x 8 mm			
6	Grubberschare	CV0 045 01		44,5 mm			
	Grubberschare	CV0 060 01		60 mm			
	Grubberschare	CV0 070 05		70 mm			
	Grubberschare	CV0 075 01		75 mm			
	Grubberschare	CV0 080 01		44,5 - 70 mm			
7	Grubberschare	CV0 080 03	Seitenblech	75 mm			
	Breitschare	CV0 080 02	Breitschar	70 mm			
	Breitschare	CV00800B	Seitenblech	70 mm			

Rechnungs-u.Lieferadresse

Fax an / to +43 3858 6055 409

.....

Kontaktpersonerson:

Anfrage / Bestellung

Datum

Bild picture	passend für	Art. Nr.	Ref. Nr.		STK pcs	EUR / Stk. EUR / pcs	Summe Total EUR
	Breitschare	CV00800C	Schneidblech	70 mm			
	Wendeschar	CV0 08006	FL 100 x 12	45 - 75 mm, M12			
	Flügelschare	CL0 000 33		939 50 220 1			
	Flügelschare	CL0 000 34		939 50 221 1			
8	Scharfuß	CL1 001 49	467 9105	10 mm			
9	Flügelschare 10 mm	CL1 001 28	337 4412 re	FL 33			
	Flügelschare 10 mm	CL1 001 29	337 4413 li	FL 33			
	Flügelschare 12 mm	CL1 001 33	337 4416 re	FL 35 D			
	Flügelschare 12 mm	CL1 001 34	337 4417 li	FL 35 D			
10	Flügelschare 12 mm	CL1 001 35	337 4418 re	FL 35 D gekr.			
	Flügelschare Hartm. 12 mm		337 4418 D re	FL 35 D gekr.			
	Flügelschare 12 mm	CL1 001 36	337 4419 li	FL 35 D gekr.			
	Flügelschare Hart.		337 4419 D li	FL 35 D gekr.			
	Flügelschare 12 mm	CL1 001 38	337 4420 re	FL 37 D gekr.			
	Flügelschare 12 mm		337 4420 D re	FL 37 D gekr.			
	Flügelschare 12 mm	CL1 001 39	337 4421 li	FL 37 D gekr.			
	Flügelschare 12 mm		337 4421 D li	FL 37 D gekr.			
	Flügelschare gekr.	CL1 001 45	337 4424-C re				
Flügelschare gekr.	CL1 001 46	337 4425-C li					
11	Scharspitze	CL1 001 31	337 4388	S12D - 10 mm			
	Scharspitze	CL1 001 30	337 4390	S 12 - 8 mm			
	Scharspitze	CL1 001 31P	337 4392	S12D gepanzert			
	Scharspitze	CL1 001 ..	337 4392	S12D o. Panzerung 12 mm			
12	Leitblech	CL1 001 32	337 4395	LB1 8 mm			
	Randleitblech	CL1 001 43	337 4398 re	337 4398			
	Randleitblech	CL1 001 44	337 4399 li	337 4399			
	SUMME ab Werk						